

Article number: 201035011

Description: E+G Positioning bushing
GN 412.2-M16x1,5-B12,2

Measures

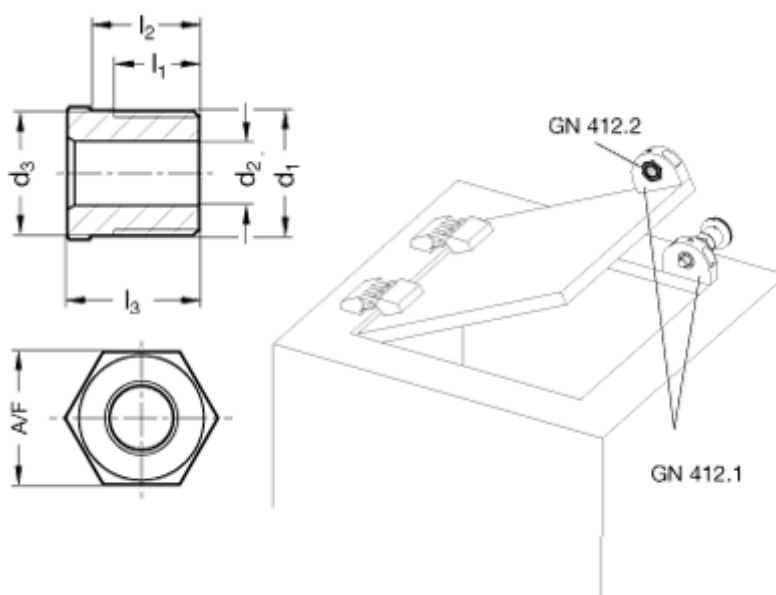

d1 = M 16 x 1,5

d2 = B 12,2

d3 = 12,1

l1 = 11

l2 = 14

l3 = 17

sw = 17